

Моноблок К350.05
Материал: сополимер пропилена

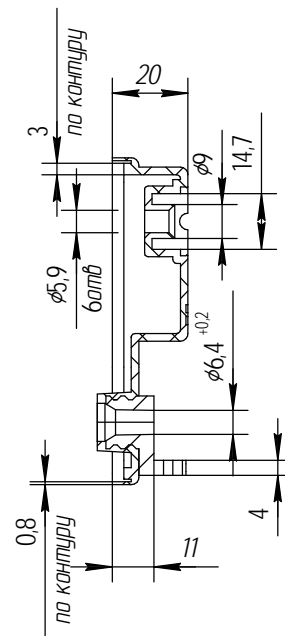

*Вариант
исполнения*

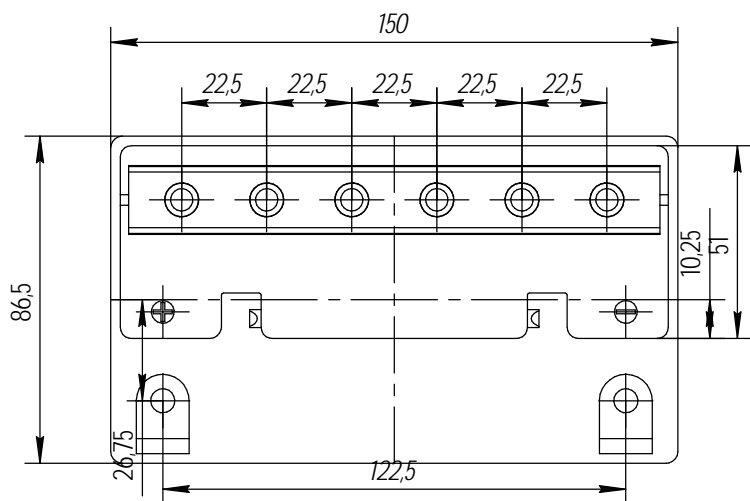
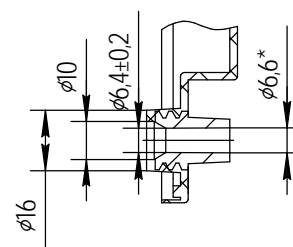
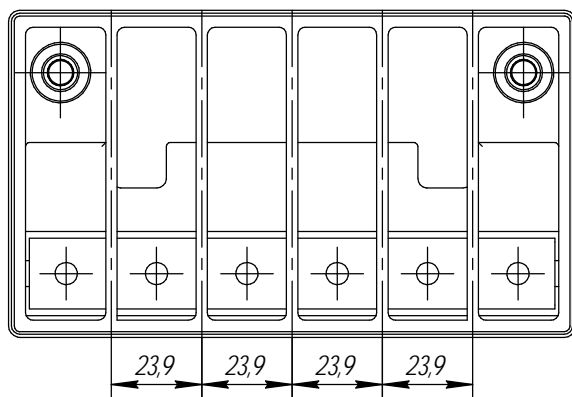

Крышка K350.00
Материал: сополимер пропилена