

Моноблок Б140.06.00.001
 Материал: сополимер пропилена

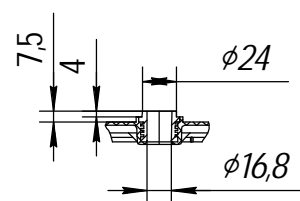
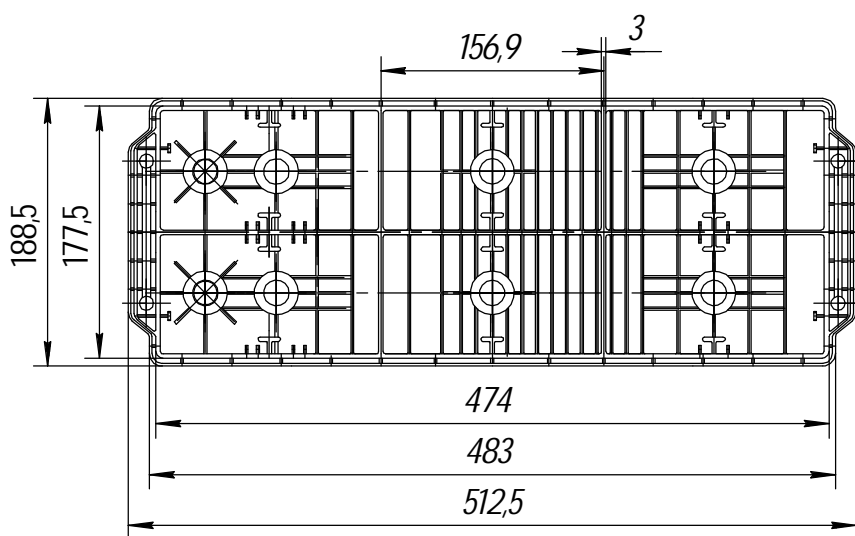
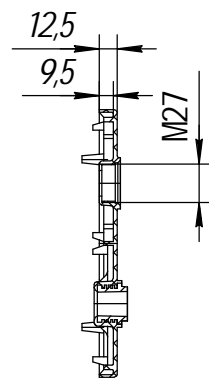
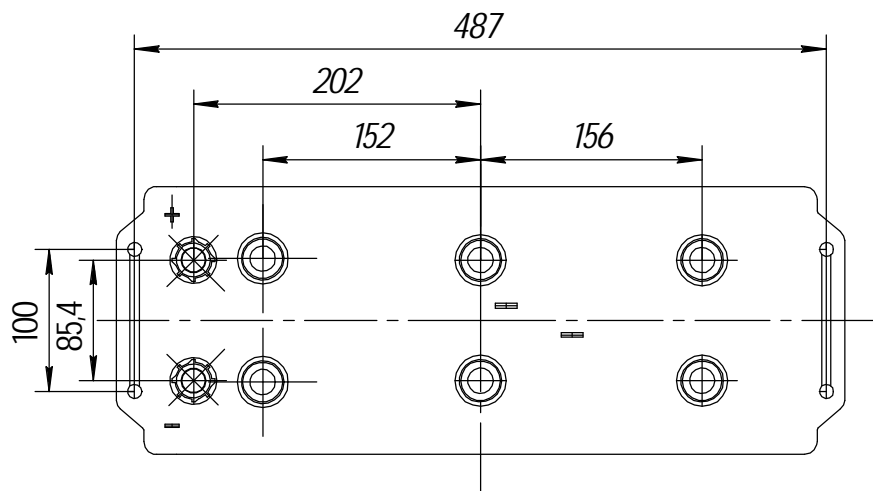

Крышка Б140.06.04.000
 Материал: сополимер пропилена